

IP66 Polycarbonate Enclosures

200 x 150 x 75mm

Manufactured from high-grade polycarbonate, this series is lightweight, with good UV resistance and a wide operating temperature, making them ideal for an array of applications, including outdoor placement.

There are 22 sizes to select from, with self-tapping stand-offs and a quick-release fastener which is simply pressed in and locked into the holes in the cover.

Accessories such as mounting plates, mounting rails or terminal blocks are available.



Features

- Polycarbonate (ABS also available)
- Rated IP66
- Quick release fastener
- Self-tapping stand-offs
- Optional transparent lid

Specification

- Foamed PUR seal (-40°C to +100°C)
- Self-locking, stainless steel fastener
- Temperature range: -40°C to +120°C
- Light Grey (RAL 7035)

Suitable Applications

- Industrial automation - switches, membrane key pads & LCD displays
- Sensors
- Lighting
- Medical apparatus and more

Bespoke Machining

- We can machine, finish, and populate your enclosures in preparation for their installation.
- We will adhere to your timescales and budget
 - You will receive engineering support
 - We can source all relevant components

DEM Manufacturing
Deltron Emcon House
Hargreaves Way
Sawcliffe Industrial Park
Scunthorpe
DN15 8RF



+44 (0)1724 273206

sales@dem-uk.com

www.dem-uk.com/deltron-enclosures

IP66 Polycarbonate Enclosures

200 x 150 x 75mm

What sizes are available in this range?

Size (mm) (L x W x H)	Polycarbonate Part Number	Size (mm) (L x W x H)	Polycarbonate Part Number
52 x 50 x 35	477-050503A-66	200 x 120 x 75	477-201207A-66
65 x 50 x 35	477-060503A-66	200 x 120 x 90	477-201209A-66
82 x 80 x 55	477-080805A-66	240 x 120 x 100	477-241210A-66
82 x 80 x 85	477-080808A-66	200 x 150 x 75	477-201507A-66
120 x 80 x 55	477-120805A-66	240 x 160 x 90	477-241609A-66
120 x 80 x 85	477-120808A-66	240 x 160 x 120	477-241612A-66
160 x 80 x 55	477-160805A-66	300 x 230 x 85	477-302308A-66
160 x 80 x 85	477-160808A-66	360 x 200 x 150	477-360215A-66
122 x 120 x 55	477-121205A-66	300 x 230 x 110	477-302311A-66
122 x 120 x 85	477-121208A-66	250 x 160 x 90	477-251609A-66
160 x 120 x 90	477-161209A-66	250 x 160 x 120	477-251612A-66

What are the Polycarbonate material properties?

Material Properties	Unit	Polycarbonate
Density	g/cm ³	1.2
Impact Resistance	mJ/mm ²	65
Toughness	mJ/mm ²	20
Tensile Strength	N/mm ²	65
Elongation of break	%	90
Modulus of elasticity (bend test)	N/mm ²	23000
Flexural stress at given strain	N/mm ²	95
Flammability	Class	V 2
Volume Resistivity	Ohms x cm	10 ¹⁵
Surface Resistance	Ohms x cm	≥ 10 ¹⁵
Dielectric Strength	kV/mm	25-40
Thermal Conductivity (20°C)	W/mK	0.21

Polycarbonate

- Lightweight
- High impact resistance
- Wide operating temperature
- Good UV resistance
- Aesthetically pleasing
- Cost effective material for placement in harsh environments when combined with ingress protection.
- UL available upon request

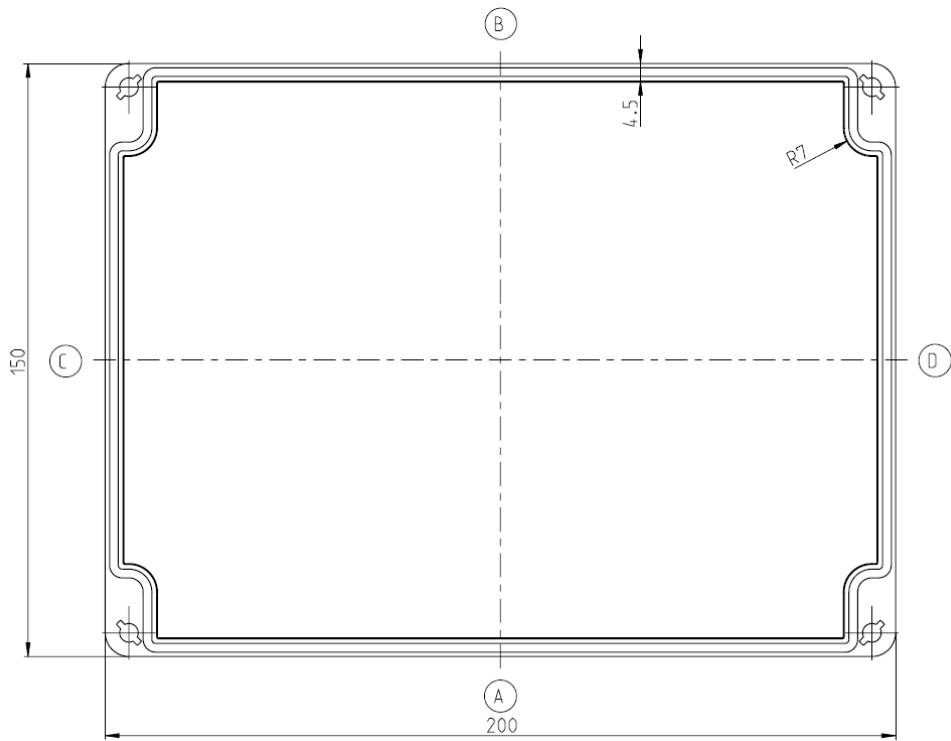

Lid

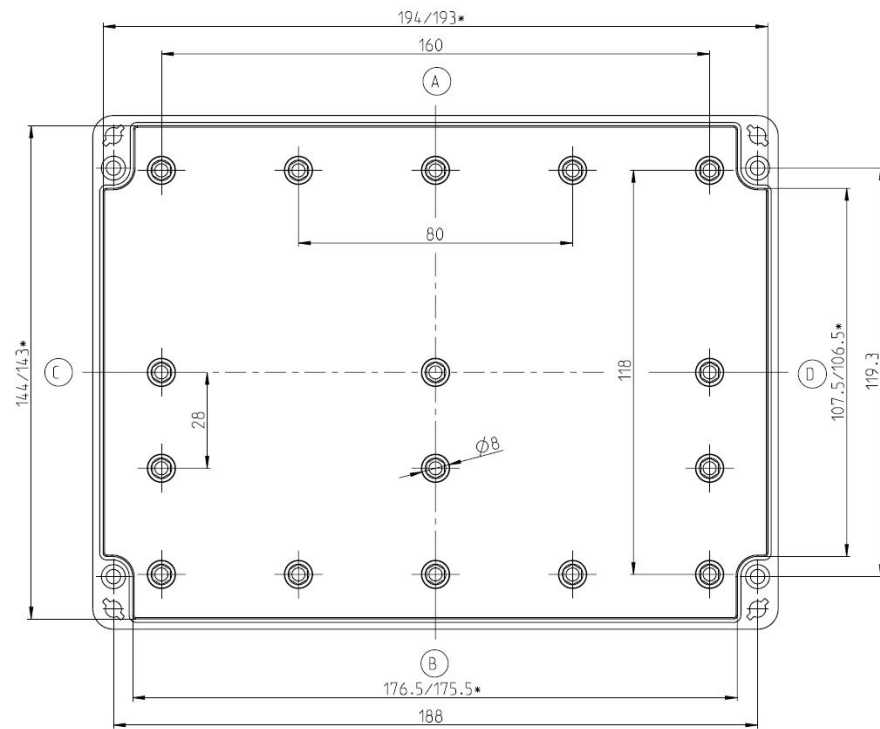

Base

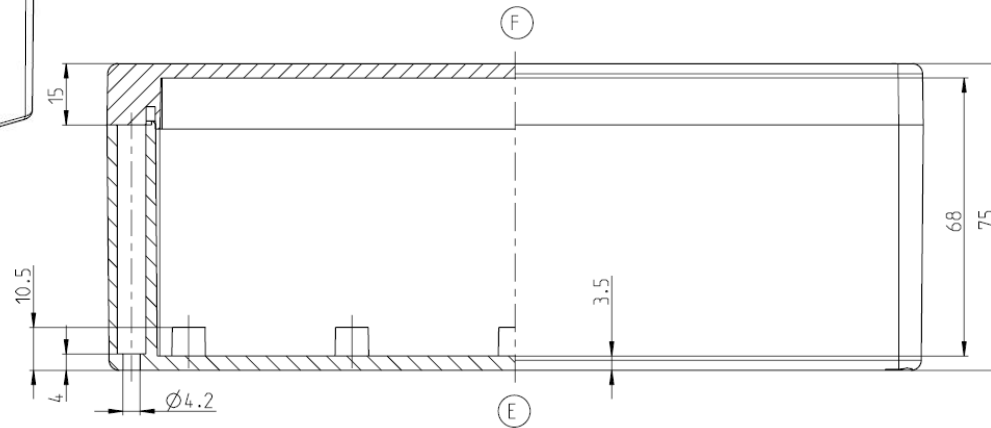
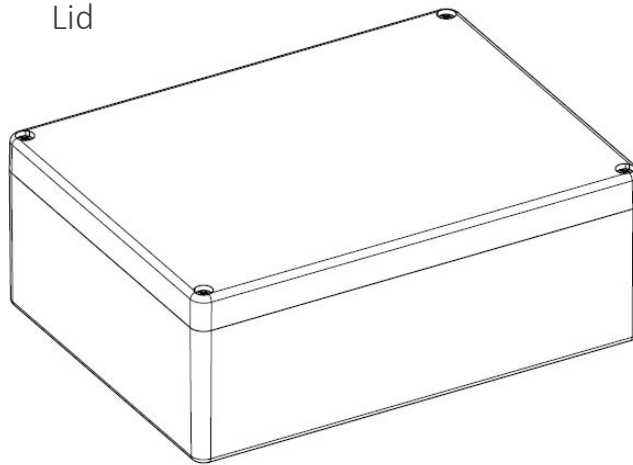

Part Number	477-201507A-66
Dimensions	200 x 150 x 75mm
Material	Polycarbonate
IP Rated	IP66
Finish	Plain



DEM Manufacturing is a division of Alpha 3 Manufacturing Ltd.

DEM Manufacturing, Deltron Emcon House, Hargreaves Way, Sawcliffe Industrial Park, Scunthorpe, North Lincolnshire, DN15 8RF.

+44 (0)1724 273206
sales@dem-uk.com
www.dem-uk.com

Deltron Enclosures IP66
Polycarbonate
477-201507A-66

Updated:
March 2017