

# IP66 ABS Enclosures

## 65 x 50 x 35mm

Manufactured from high-grade ABS, this series is lightweight and sturdy with good resistance to chemicals, making them ideal for an array of indoor applications.

There are 22 sizes to select from, with self-tapping stand-offs and a quick-release fastener which is simply pressed in and locked into the holes in the cover.

Accessories such as mounting plates, mounting rails or terminal blocks are available.



### Features

- ABS (Polycarbonate also available)
- Rated IP66
- Quick release fastener
- Self-tapping stand-offs
- Cost effective

### Specification

- Foamed PUR seal (-40°C to +100°C)
- Self-locking, stainless steel fastener
- Temperature range: -40°C to +80°C
- Light Grey (RAL 7035)

### Suitable Applications

- Industrial automation - switches, membrane key pads & LCD displays
- Sensors
- Lighting
- Medical apparatus and more

### Bespoke Machining

- We can machine, finish, and populate your enclosures in preparation for their installation.
- We will adhere to your timescales and budget
  - You will receive engineering support
  - We can source all relevant components

DEM Manufacturing  
Deltron Emcon House  
Hargreaves Way  
Sawcliffe Industrial Park  
Scunthorpe  
DN15 8RF



+44 (0)1724 273206

sales@dem-uk.com

[www.dem-uk.com/deltron-enclosures](http://www.dem-uk.com/deltron-enclosures)

# IP66 ABS Enclosures

## 65 x 50 x 35mm

### What sizes are available in this range?

Size (mm) (L x W x H)	ABS Part Number	Size (mm) (L x W x H)	ABS Part Number
52 x 50 x 35	478-050503A-66	200 x 120 x 75	478-201207A-66
65 x 50 x 35	478-060503A-66	200 x 120 x 90	478-201209A-66
82 x 80 x 55	478-080805A-66	240 x 120 x 100	478-241210A-66
82 x 80 x 85	478-080808A-66	200 x 150 x 75	478-201507A-66
120 x 80 x 55	478-120805A-66	240 x 160 x 90	478-241609A-66
120 x 80 x 85	478-120808A-66	240 x 160 x 120	478-241612A-66
160 x 80 x 55	478-160805A-66	300 x 230 x 86	478-302308A-66
160 x 80 x 85	478-160808A-66	360 x 200 x 150	478-360215A-66
122 x 120 x 55	478-121205A-66	300 x 230 x 110	478-302311A-66
122 x 120 x 85	478-121208A-66	250 x 160 x 90	478-251609A-66
160 x 120 x 90	478-161209A-66	250 x 160 x 120	478-251612A-66

### What are the ABS material properties?

Material Properties	Unit	ABS
Density	g/cm <sup>3</sup>	1.05
Impact Resistance	mJ/mm <sup>2</sup>	60
Toughness	mJ/mm <sup>2</sup>	10
Tensile Strength	N/mm <sup>2</sup>	43
Elongation of break	%	20
Modulus of elasticity (bend test)	N/mm <sup>2</sup>	21000
Flexural stress at given strain	N/mm <sup>2</sup>	90
Flammability	Class	HB
Volume Resistivity	Ohms x cm	10 <sup>13</sup>
Surface Resistance	Ohms x cm	4 x 10 <sup>14</sup>
Dielectric Strength	kV/mm	24
Thermal Conductivity (20°C)	W/mK	0.18

#### ABS

- Lightweight
- Sturdy
- Good chemical resistance
- Cost effective
- Good insulating properties
- Easy to machine, paint and colour

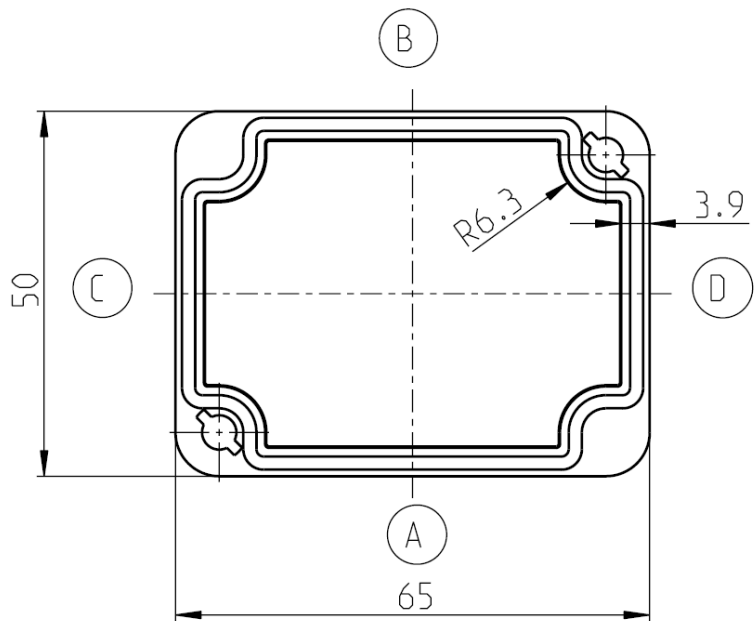

Lid

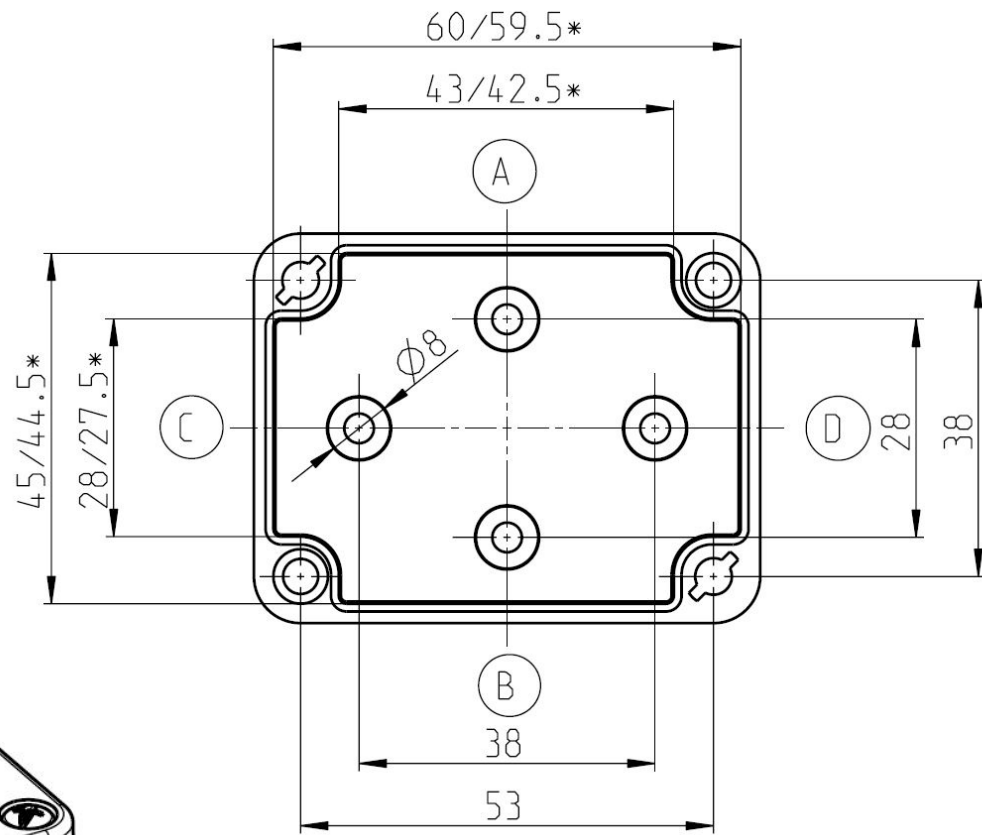

Base

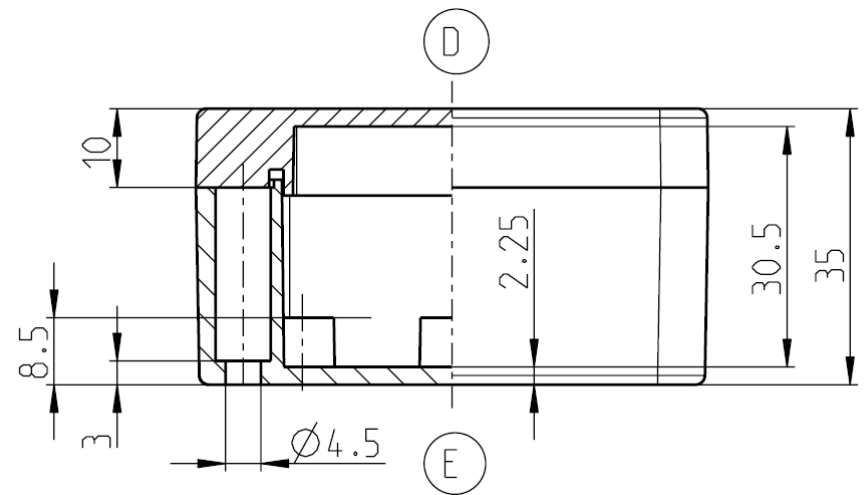
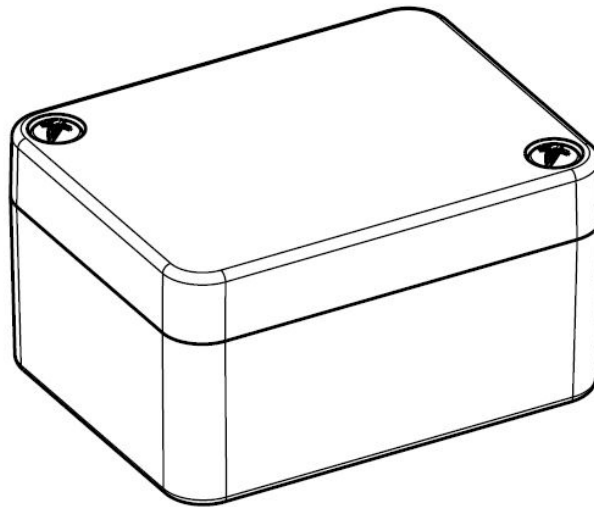

Part Number	478-060503A-66
Dimensions	65 x 50 x 35mm
Material	ABS
IP Rated	IP66
Finish	Plain



DEM Manufacturing is a division of Alpha 3 Manufacturing Ltd.

DEM Manufacturing, Deltron Emcon House, Hargreaves Way, Sawcliffe Industrial Park, Scunthorpe, North Lincolnshire, DN15 8RF.

+44 (0)1724 273206  
sales@dem-uk.com  
www.dem-uk.com

Deltron Enclosures IP66  
ABS  
478-060503A-66

Updated:  
March 2017