

Lid

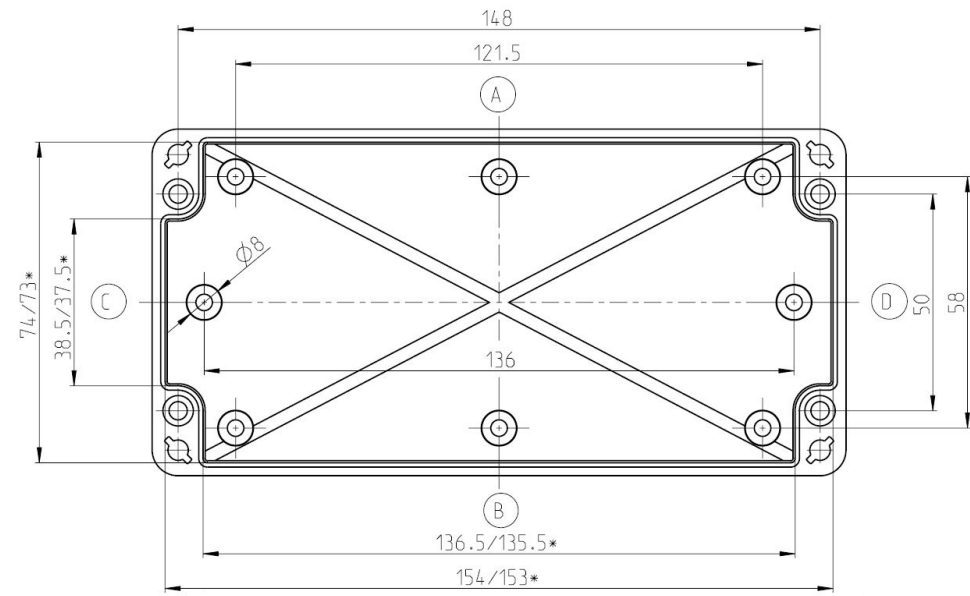

Base

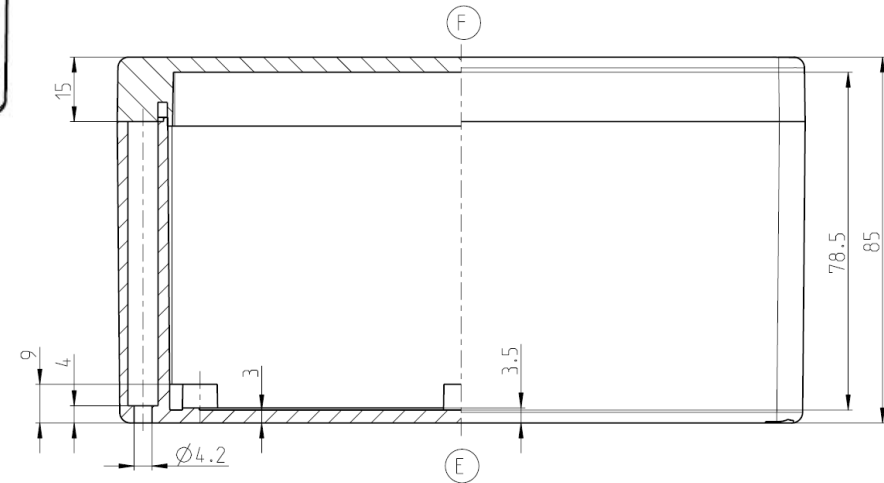
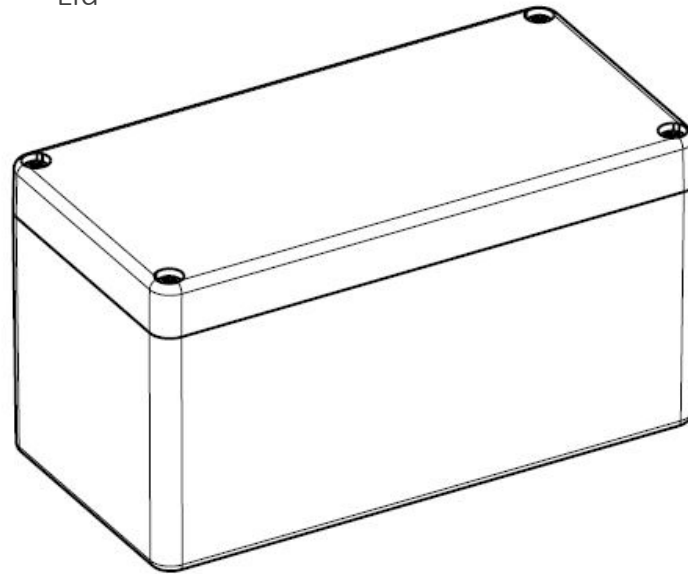

Part Number	478-160808A-66
Dimensions	160 x 80 x 85mm
Material	ABS
IP Rated	IP66
Finish	Plain



DEM Manufacturing is a division of Alpha 3 Manufacturing Ltd.

DEM Manufacturing, Deltron Emcon House, Hargreaves Way, Sawcliffe Industrial Park, Scunthorpe, North Lincolnshire, DN15 8RF.

+44 (0)1724 273206  
sales@dem-uk.com  
www.dem-uk.com

Deltron Enclosures IP66  
ABS  
478-160808A-66

Updated:  
March 2017